

STRIP-TEC WIRE STRIPPER

MODEL 1000



Strip Technology, Inc.

3700 N. Commerce St
Fort Worth, TX 76106
(800) 426-4126

**NASCO-OP**TM
Power of Numbers
800.321.3396
nascoop.com

STRIP TECHNOLOGY

Strip Technology, a leader cable and wiring recovery systems, offer 4 patented wire strippers. Built tough, to be efficient and dependable, at our manufacturing facility in Fort Worth, Texas, Strip Technology can also custom build any cable/wire recovery system to your specs. Call us at 1.800.426.4126 or 1.817.626.1504 and ask how we can fill your wire stripping needs.

Strip Technology is one of the many business ventures created by the Alexander family. Founded by Bill Alexander, Sr. and now run by his immediate family, Ronnie, Bobby and Bill Alexander Jr., Strip Technology is based on the family's tradition of quality at a reasonable price.

Driven by the demand to conserve and noting that our world only has a finite amount of raw materials, Strip Technology was born. Recycling is not only smart, in that it conserves resources, but it also profitable, because raw materials are not needed to produce an end product that you can recover. There is no pollution, no hazardous byproducts and no manufacturing labor involved.

The Alexander's base their integrity on 3 generations of family ownership and dedication to you, the customer. Our company's no-nonsense approach and 'esprit de corp' attitude of our employees only enhance the kind of workmanship we place into everything we manufacture.

Strip Technology has 4 patented wire strippers on the market today. Give us, or one of our authorized dealers a call if you require any special applications. We can custom build a wire stripper specifically for you.

TABLE OF CONTENTS

SECTION ONE – INTRODUCTION

- 1-1, Model 1000 S/N Plate
- 1-2, Specifications
- 1-3, Model 1000 Limited Warranty

SECTION TWO – FREIGHT NOTICE

- 2-1, Freight Notice
- 2-2, Unpacking Wire Stripper

SECTION THREE – SAFETY PRECAUTIONS

- 3-1, General
- 3-2, Before Operating the Wire Stripper
- 3-3, Observe Electrical Precautions
- 3-4, Caution Labels

SECTION FOUR – OPERATIONS

- 4-1, Operations
 - A. Connect units to the proper power source as follows
 - B. Observe All Warning and Danger Signs
 - C. Start and Stop Buttons
 - D. Emergency Stop Button
 - E. Adjusting The Cutting Blades
 - F. Over Tightening of Cutter Blades

SECTION FIVE – MAINTENANCE and REPAIR

- 5-1 Maintenance
 - A. Service Points

SECTION SIX – PARTS ILLUSTRATIONS

- Figure 1, Cutter System
- Figure 2, Drive System
- Figure 3, Electrical System - Single Phase - 120 volt

SECTION SEVEN – VENDOR LITERATURE

SECTION ONE

INTRODUCTION

1-1 Model 1000 Strip-Tec Wire Stripper

Strip Technology, Inc. machines are designed and built to give long and trouble-free life, providing that you conduct the simple maintenance procedures detailed in this manual.

Remember that removing the outer insulation cover off the wire can be hazardous. Before operating the **Wire Stripper**, it is important that the operator reads the safety instructions contained in this manual (section 3). Please ensure that your operators are fully trained in the use of the **Wire Stripper** and that you should conduct periodic safety reviews of the equipment's **safety features** and **warning labels**.



If you need any further help or assistance, or with to order parts for the Wire Stripper please contact your distributor or the manufacturer:

Strip Technology, Inc.

3700 N. Commerce St
Fort Worth, TX 76106
(800) 426-4126

SECTION ONE

INTRODUCTION

1-2 MODEL 1000 SERIAL NUMBER PLATE

Before operating the **Wire Stripper** the unit must be wired and grounded in accordance with **National Electrical Codes** including any and all **Local** codes.

The **VENT PLUG** is to be installed on the **GEAR REDUCER** before starting this product.

MOTOR:

Model Number _____

Voltage: _____

Phase: _____

Serial Number: _____

Supply Circuit: _____ **Amps MAX**

1-3 SPECIFICATIONS:

Motor: 1 HP, 110 volts, Single Phase

Production: Approx. 50 ft/minute

Machine Height: 37 inches

Machine Length: 46 inches

Wire Size: 1/16 to 1 inch diameter

Weight: 100 lbs

SECTION ONE

INTRODUCTION

1-4 MODEL 1000 LIMITED WARRANTY.

Strip Technology, Inc., (warrantor) warrant to the original consumer purchaser only that all products manufactured or supplied by warrantor will be free from defects in material and workmanship under normal use and service for the period of 90 days from the date of purchase for all warranted products. (Proof of purchase required)

This warranty does not cover damage from normal wear and tear, accident, misuse, or lack of reasonable and necessary maintenance and service, nor does it warranty the improper installation or unauthorized repair, alteration, modification, or defects in the unit when product is installed.

In the event of a warranted product defect, please call Strip Technology, Inc., with a description of the defect. It is Strip Technology, Inc.'s option to repair or replace with functionally equivalent product. Proof of purchase and the return of product may be required for replacements. Such repair or replacement shall be at warrantor's expense, but you shall bear all other expenses, including, but not limited to, cost of removal, transportation, re-installation, communication and any special service requested by you such as overtime labor, ect. Repaired or replaced items carry only the un-expired portion of the original warranty.

EXCEPT TO THE EXTENT PROHIBITED BY APPLICABLE LAW, ALL IMPLIED WARRANTIES, INCLUDING WARRANTIES OF MERCHANTABILITY AND FITNESS FOR A PARTICULAR PURPOSE, ARE LIMITED IN DURATION TO THE SHORTER OF THE PERIOD PROVIDED BY LAW OR THE PERIOD OF THE WARRANTY AND UNDER NO CIRCUMSTANCES SHALL **STRIP TECHNOLOGY, INC.**, BE LIABLE FOR INCIDENTAL OR CONSEQUENTIAL DAMAGES SUSTAINED IN CONNECTION WITH THE PRODUCT. THE EXPRESS WARRANTY ABOVE CONSTITUTES THE ENTIRE WARRANTY AND IS IN LIEU OF ALL OTHERS EXPRESSED OR IMPLIED.

Some states do not allow the exclusion or limitation of consequential damages, or limitation on how long an implied warranty lasts, so the above limited or exclusions may not apply to you.

This warranty gives you specific legal rights, and you may also have other rights, which vary from state to state.

Customer Service Department
800-426-4126 Phone
817-625-2207 Fax

Strip Technology, Inc.

SECTION TWO

PREPARATION FOR USE

2.1 FREIGHT NOTICE

If crate and **Wire Stripper** should arrive to your company damaged, immediately take photos of damage and fill out the proper paper work with the freight company. Contact the manufacturer Strip Technology, Inc. to get costs of damaged parts and report to the freight company.

2.2 UNPACKING WIRE STRIPPER

CAUTION

Remove crate from around Wire Stripper and before removing Wire Stripper off of crate base be sure lifting device is correctly lifting Wire Stripper from underneath the table frame because of being top heavy.



Model 1000 Shipping Crate

SECTION TWO

PREPARATION FOR USE

2.3 PRELIMINARY SERVICING

After removing the Model 1000 Wire Stripper from its shipping crate, set the unit in its proper operating position (see figure 2-1).



Figure 2-1 Model 1000 Wire Stripper

The Model 1000 Wire Stripper was shipped completely serviced except for the VENT PLUG being installed.

To install VENT PLUG remove the pipe plug and install the VENT PLUG shown in figure 2-2.

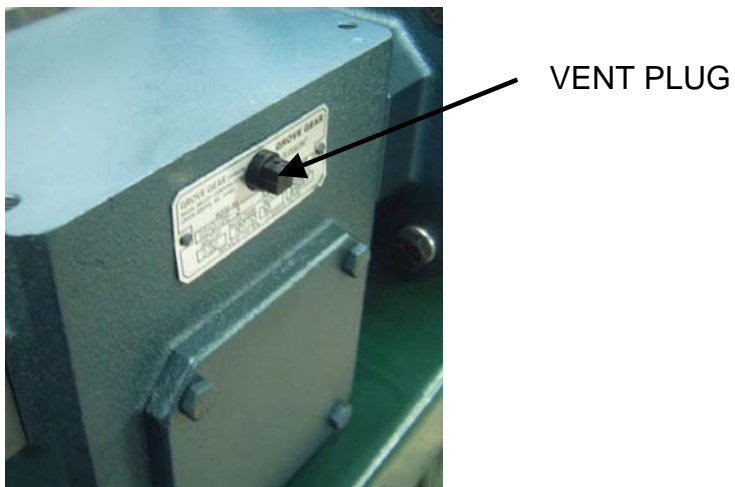

Figure 2-2 Gear Box Vent Plug

SECTION THREE

SAFETY PRECAUTIONS

3.1 GENERAL:

It is impossible to compile a list of safety precautions covering all situations. However, there are basic safety precautions that **MUST** be followed during your daily routine. Safety is **YOUR PRIME RESPONSIBILITY**, since any piece of equipment is only as safe **AS THE PERSON OPERATING THE EQUIPMENT**.

With this in mind, this information has been provided to assist the operator, in promoting a safe working area for yourself and those around you. It is not meant to cover every conceivable circumstance which could arise. It is intended to present basic safety precautions that should be followed in daily operations.

You, the operator, are the only one who can be relied upon to assure the safety of yourself and those around you. Be a **PROFESSIONAL** and follow the **RULES** of safety.

Be aware at all times that you are responsible for the safety of yourself, your co-workers, the **WIRE STRIPPER** and everything around it.

Read and understand the Operator's Section 4 before operating the **WIRE STRIPPER**.

3.2 BEFORE OPERATING THE WIRE STRIPPER:

Be sure that the operator has read and understood this manual.

Be sure that the operator always wears eye protection.

Be sure that the operator is wearing the proper protective clothing and boots.

Inspect the entire unit before each use for worn, loose, missing, or damaged parts.

Be sure that all protective cutter blades guard plate is in proper position (see figure 3-1), wire guide plate (see figure 3-2 and drive shaft and gear cover (see figure 3-3) are in place and properly installed.



Figure 3-1 Cutter Blade Guard Figure 3-2, Guide Plate Figure 3-3, Drive Shaft Cover
Check that all safety and warning notices are clean and legible.

SECTION THREE

SAFETY PRECAUTIONS

Use proper size guide hole for wire size being stripped.

When operating the **Wire Stripper**, operator must stand on end of unit where **ON/OFF** Switch is for easy access (See figure 3-4).



Figure 3-4, ON-OFF Switch

3-3 OBSERVE ELECTRICAL PRECAUTIONS:

Wire Stripper must be wired and grounded in accordance with National Electrical Codes.

Do not use in damp or wet locations or expose to snow, rain, or water to avoid the possibility of electrical shock.

Use extension cords specifically marked suitable for outdoor use.

Inspect the insulation and connectors on the **Wire Stripper** and extension cord before each use. If there is any damage, DO NOT USE until damage is repaired by qualified service personnel.

DO NOT use ON/OFF switch if not operating properly. Repairs to switch must be made by qualified service personnel.

Keep extension cord clear of operator, and other obstacles, which may damage cord at all times.

DO NOT expose to heat, oil, or sharp edges.

Avoid any body contact with any grounded conductor, to avoid electrical shock.

SECTION THREE

SAFETY PRECAUTIONS

3-4 CAUTION LABELS

The caution labels illustrated are those attached to the **Wire Stripper**. If labels are damaged, new replacement labels can be obtained from the local distributor or manufacture. See labels below.



⚠ DANGER / PELIGRO

HAZARDOUS VOLTAGE

- At least two power sources (Line and Control) are feeding this equipment
- Disconnect ALL power to this equipment before servicing.

Electric shock will result in death or serious injury.

TENSIÓN PELIGROSA

- Por lo menos dos fuentes de alimentación (de línea y de control) alimentan este equipo.
- Desenergice el equipo antes de realizar servicios de mantenimiento.

Una descarga eléctrica podrá causar la muerte o lesiones serias.

TENSION DANGEREUSE

- Au moins deux sources d'alimentation (ligne et contrôle) alimentent cet appareil.
- Coupez toutes les alimentations à cet appareil avant d'effectuer l'entretien.

L'électrocution entraînera la mort ou des blessures graves.

72013-011-01 rev.: -

SECTION FOUR OPERATIONS

4.1 Operations

A. Connect unit to the proper power source as follows:

- The power source needs to be what is listed on the motor plate.
- Be sure that the power source electrical cable is specifically marked as suitable for outdoor use.
- Heavy enough to carry the current from the power source the full length of the power cable to the **Wire Stripper**. Otherwise loss of power and overheating can occur causing damage to the **Wire Stripper**.
- Power cable insulation must be intact with no cracks or deterioration.
- Plug connectors must be undamaged.

B. OBSERVE ALL WARNING and DANGER SIGNS.

C. Start and Stop Buttons.

- Pressing the black button "**Start**" (See figure 4-1) which will turn on the **Wire Stripper**.



Figure 4-1, Starter Panel

- Pressing the red button "**STOPS**", stops the **Wire Stripper** (See figure 4-1)

SECTION FOUR OPERATIONS

D. Adjusting the cutting blades:

- Insert wire into the proper guide hole until wire passes over center of cutting blades. (See figure 4-2).

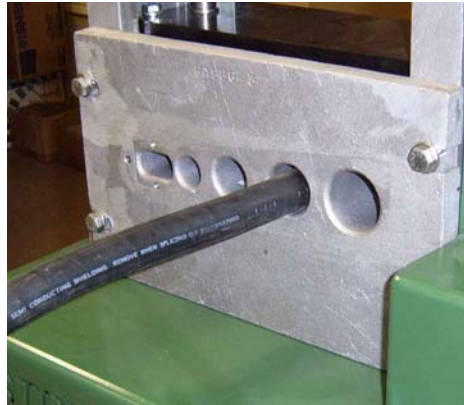

Figure 4-2 Wire in 1" Guide Plate.

- Tighten cutting blades until they penetrate into the outer wire cover. (See figure 4-3).

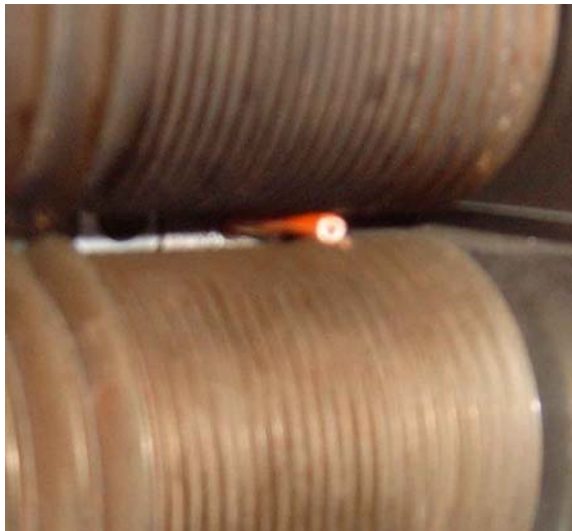

Figure 4-3, Wire between cutter blades.

SECTION FOUR OPERATIONS

- Turn on Wire Stripper so the cutter blades can cut into outer cover. (See figure 4-4).



Figure 4-4, Wire cut.

- Turn Wire Stripper off and again turn cutting blades so they can fully penetrate outer wire cover until they touch the wire. (See Figure 4-5)



Figure 4-5

SECTION FOUR OPERATIONS

- Turn Wire Stripper on for continued operation.



Figure 4-6 Cable wire finish cut.

- F. Over tightening of cutting blades into WIRE will cut WIRE into short splinters and also damage cutting blades and other components.
(See Figure 4-7)



Figure 4-7 Splinters

SECTION FIVE

MAINTENANCE and REPAIR

5.1 MAINTENANCE

A. Check the following service points on a monthly basis:

- Remove cover by removing two (2) cap screws and lock washers that secures the cover to the table top (see figure 5-1).



Figure 5-1, Drive Yoke and Gears Cover

- Grease gears (see figure 5-2).

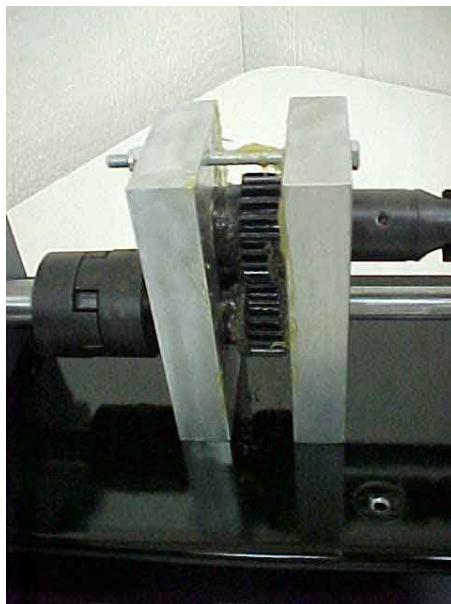

Figure 5-2 Spur Gears

SECTION FIVE

MAINTENANCE and REPAIR

- Cutter Blades (see figure 5-3). Inspect for damage such as flat spots or chipped out blade.



Figure 5-3, Cutter Blades

If you need any further help or assistance, or wish to order parts for the Wire Stripper please contact you distributor or the manufacturer:

Strip Technology, Inc.

3700 N. Commerce St
Fort Worth, TX 76106
(800) 426-4126

SECTION SIX

PARTS ILLUSTRATIONS

FIGURE 1, Cutter System

FIGURE 2, Drive System

FIGURE 3, Electrical System - Single Phase - 120 volt

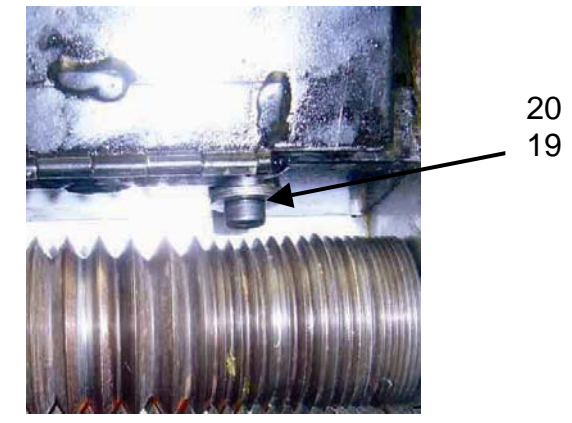
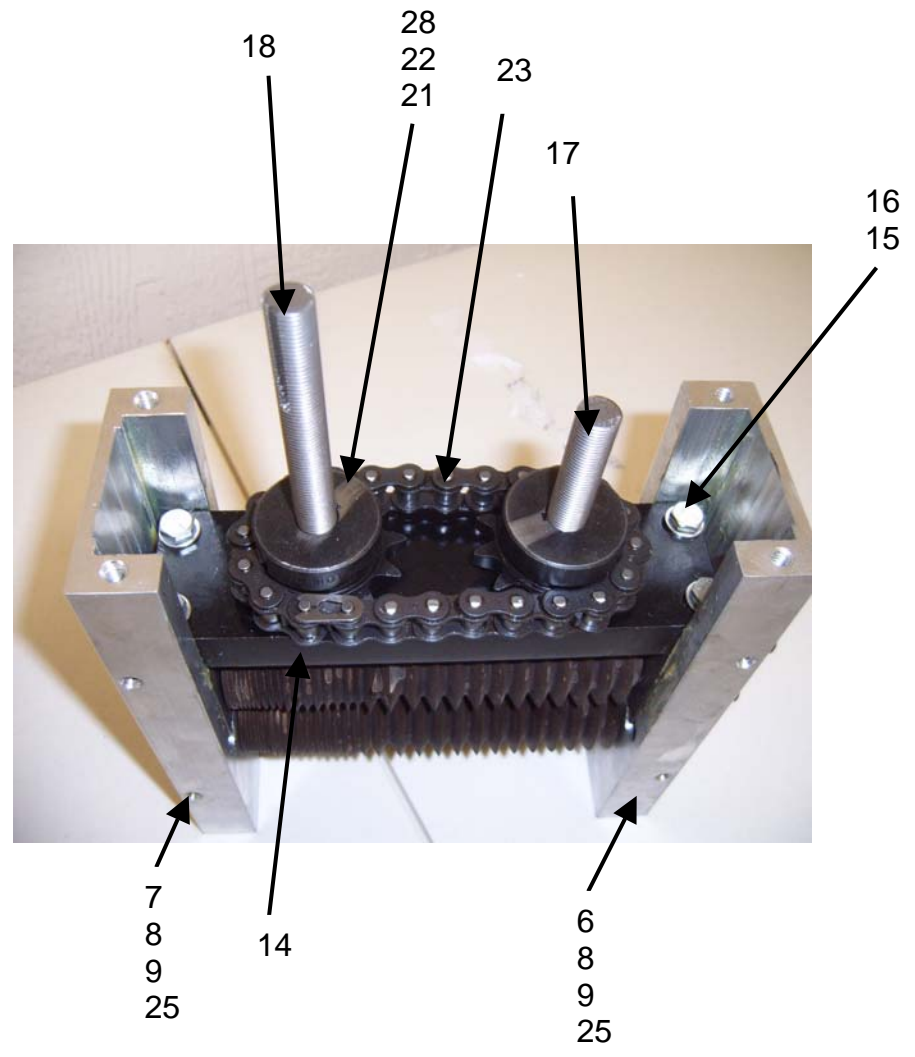
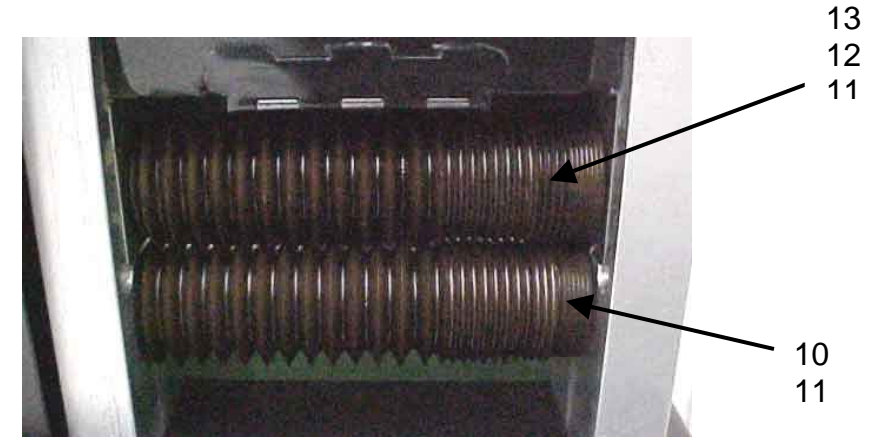
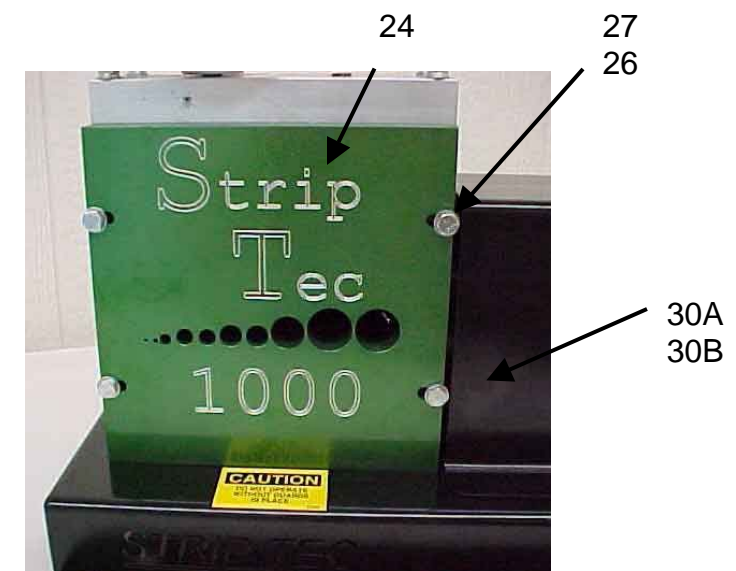
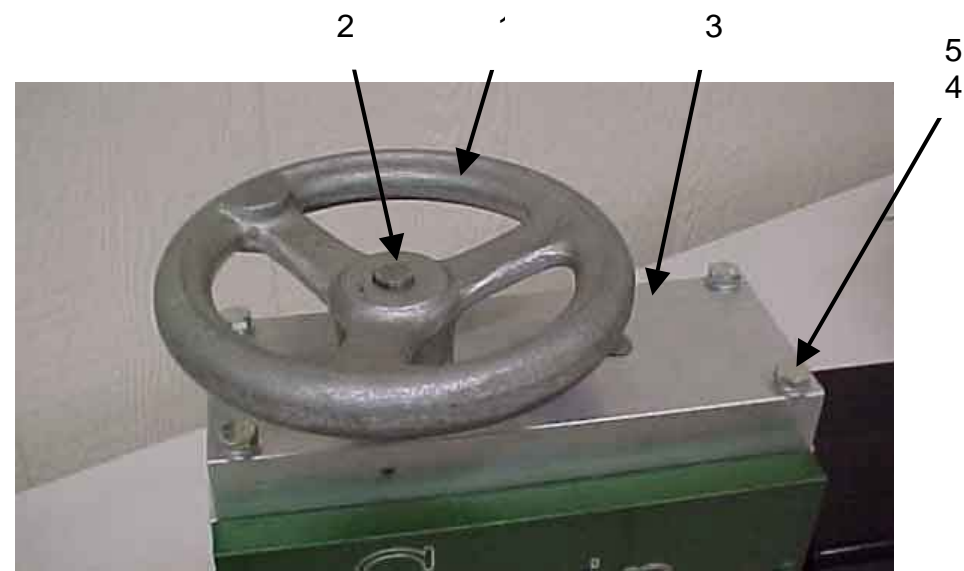

30B	1	011-BA205-9-UK-LID	LID (UK)
30A	1	001-BA205-9-LID	LID
29B	1	001-BA205-9-UK-TABLE	TABLE
29A	1	001-BA205-9-TABLE	TABLE
28	2	BA986-12	SETSCREW, 1/4"
27	4	HHCS-39	CAPSCREW, Hx Hd, 1/4-20 x 1" Lg
26	4	FW-3	FLATWASHER, 1/4"
25	4	FW-1	FLATWASHER, 3/8"
24	1	001-BA205-5	PLATE, Guide, Wire (Alum)
23	1	001-BA205-19	CHAIN, #40 x 12" Lg
22	2	BA-986-20	KEYSTOCK, 1/8" Sq - 2" Lg
21	2	BA-986-11	SPROCKET, Hand wheel (40B12)
20	8	001-BA205-21	WASHER, Thrust
19	2	001-BA205-20	BOLT, Shoulder
18	1	001-BA205-18	SCREW, Adjustment
17	1	001-BA205-17	SCREW, Adjustment
16	4	HHCS-39	CAPSCREW, Hx Hd, 1/4-20 x 1" Lg
15	4	FW-3	FLATWASHER, 1/4"
14	1	001-BA205-11	PLATE, Push
13	2	001-BA205-10	PLATE, Bearing, Adjustable
12	1	001-BA205-24	BLADE, Cutter, Top (1000)
11	4	001-BA250-6	BEARING (1623 DC)
10	1	001-BA205-25	BLADE, Cutter, Bottom, 1000
9	4	HHCS-3	CAPSCREW, Hx Hd, 3/8-16 x 7/8" Lg
8	4	LW-2	LOCKWASHER, 3/8"
7	1	001-BA205-2	FRAME, Side, Right (Alum)
6	1	001-BA205-1	FRAME, Side, Left (Alum)
5	4	HHCS-40	CAPSCREW, Hx Hd, 1/4"-20 x 1-1/2" Lg
4	4	LW-3	LOCKWASHER, 1/4"
3	1	001-BA205-3	PLATE, Boss, V-Thread (Alum)
2	1	BA-986-20	KEYSTOCK, 1/8" Sq. x 1" Lg
1	1	BA-986-14	WHEEL, Hand
ITEM	REQ'D	PART NUMBER	DESCRIPTION

Figure 6-1, Cutter System (Model 1000)

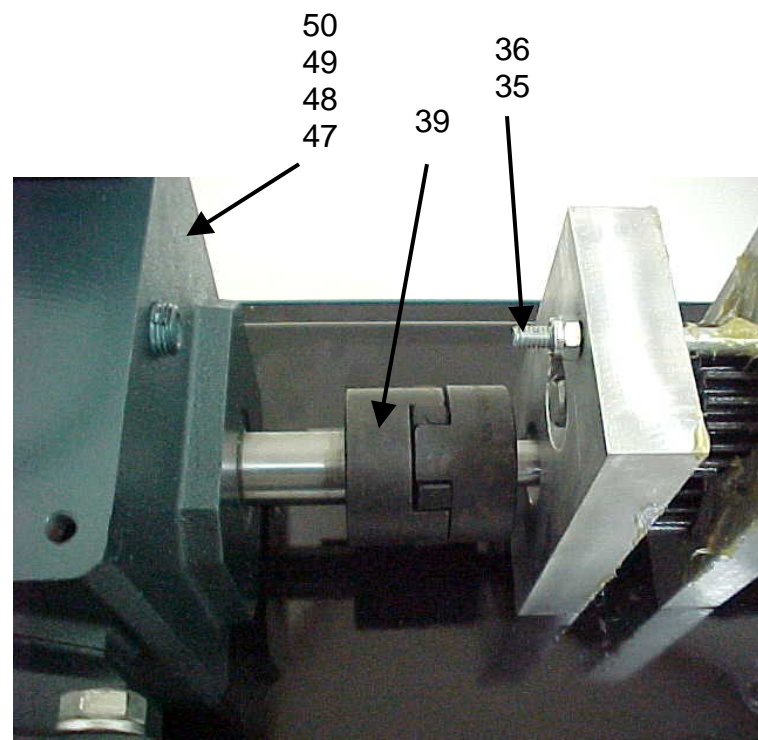
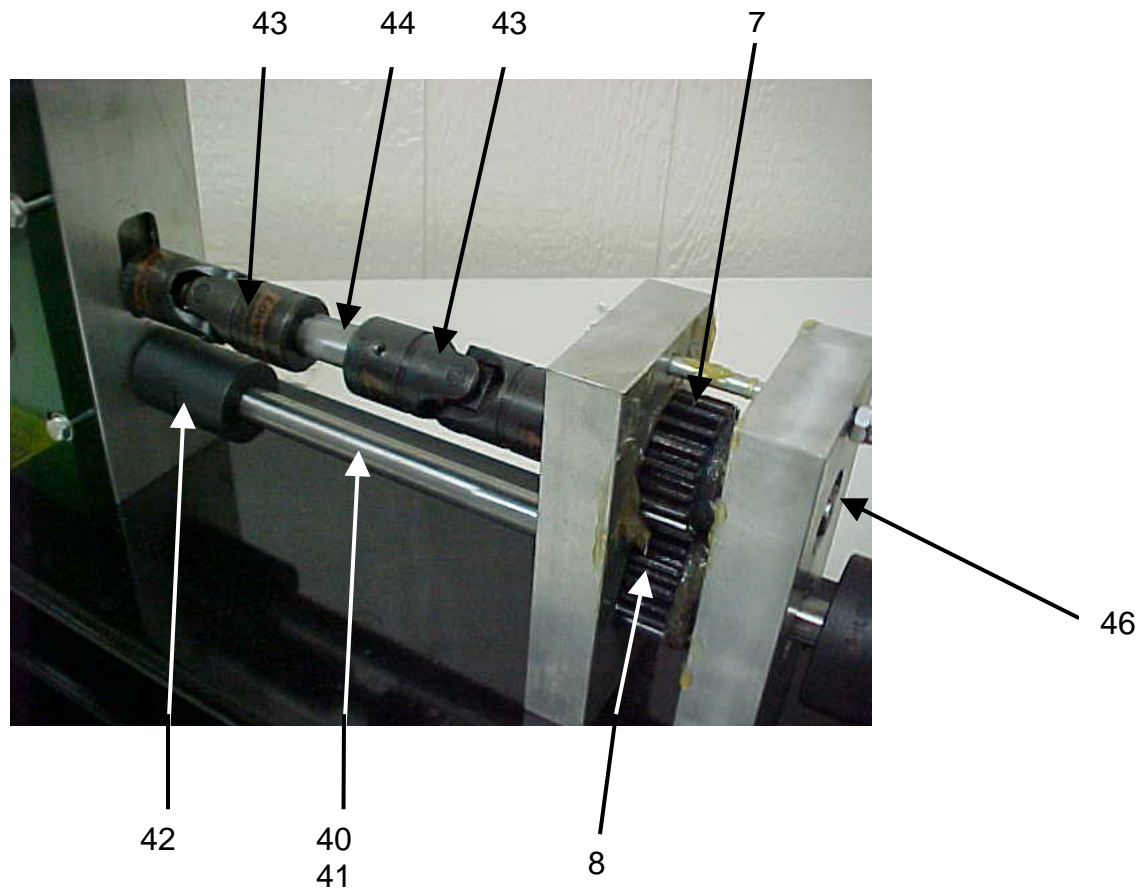
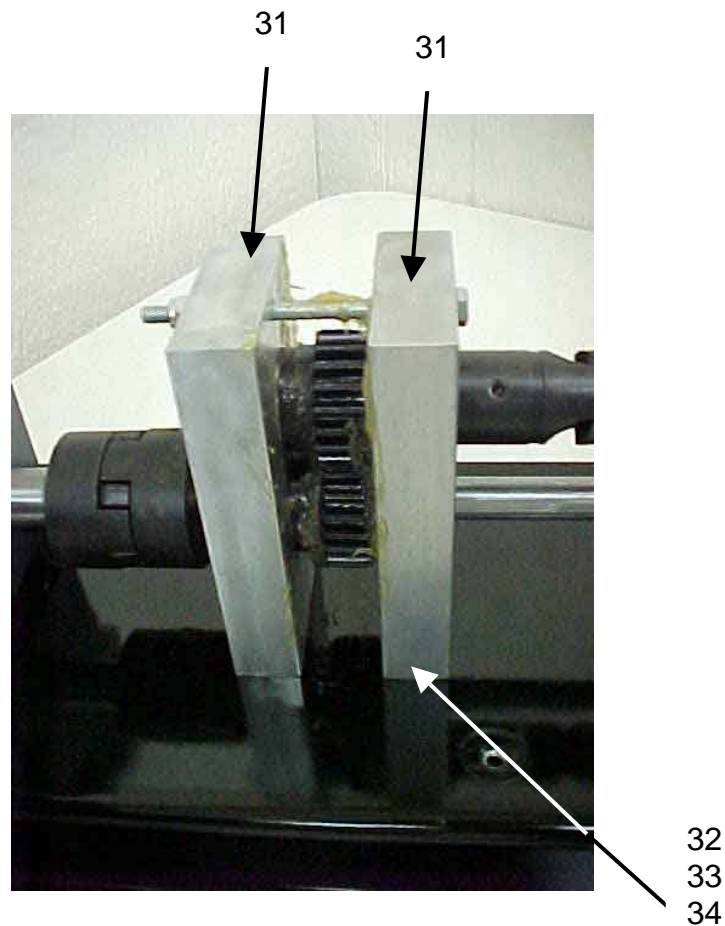

50	4	HHCS-4	CAPSCREW, Hx Hd, 5/16-18 x 7/8" Lg
49	4	LW-4	LOCKWASHER, 5/16
48	4	FW-4	FLATWASHER, 5/16
47	1	011-BA205-22	REDUCER, Gear, (Grove 20:1)
46	1	001-BA205-13	SHAFT, Gear, 5/8" Dia x 4" Lg
45	1	001-BA205-31	KEYSTOCK, 1/8" Sq x 3-1/2" Lg
44	1	001-BA205-12	SHAFT, Yoke, Slip, 5/8" Dia x 3-1/2" Lg
43	2	001-BA205-15	COUPLING, Yoke
42	1	001-BA205-26	COUPLING, Blade, Cutter
41	2	001-BA205-14A	KEYSTOCK, 3/16" Sq x 1" Lg
40	1	001-BA205-14	SHAFT, Drive, 5/8" Dia x 12" Lg
39	1	001-BA205-16	COUPLING, Spider (Love-Joy)
38	1	001-BA205-8	GEAR, Bottom (S1222)
37	1	001-BA205-7	GEAR, Top (S1220)
36	1	NYLOCKNUT-2	NUT, Nylock, 1/4-20
35	1	HHCS-45	CAPSCREW, Hx Hd, 1/4-20 x 3-3/4" Lg
34	4	HHCS-3	CAPSCREW, Hx Hd, 3/8-16 x 7/8" Lg
33	4	LW-2	LOCKWASHER, 3/8"
32	4	FW-1	FLATWASHER, 3/8"
31	2	001-BA205-4	FEET, Box, Gear (Alum)
ITEM	REQ'D	PART NUMBER	DESCRIPTION

Figure 6-2, Drive System (Model 1000)



58

59

60



61A
61B

62

57
56

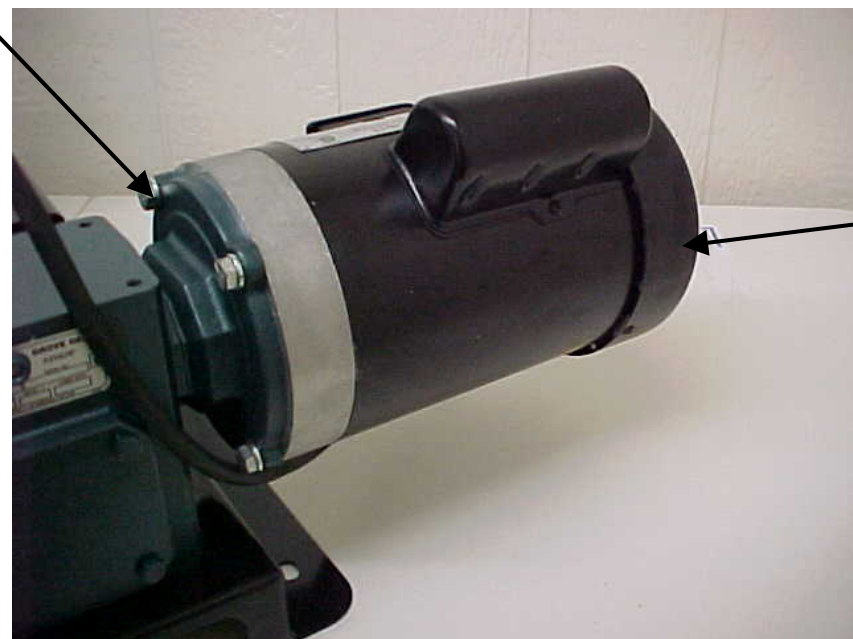

55

ITEM	REQ'D	PART NUMBER	DESCRIPTION
62	2	HHCS-4	CAPSCREW, Hx Hd, 5/16-18 x 7/8" Lg
61B	1	001-BA205-9-UK-BRKT	BRACKET (Start/Stop)
61A	1	001-BA205-9-BRKT	BRACKET (Start/Stop)
60	1	001-BA205-28	PLUG, Electrical (120 V)
59	1	001-BA205-29	CORD, Electrical, 3' Lg
58	1	001-BA205-27	BUTTON, Start/Stop
57	4	HHCS-3	CAPSCREW, Hx Hd, 3/8-16 x 7/8" Lg
56	4	LW-2	LOCKWASHER, 3/8
55	1	001-BA205-23	MOTOR (1 HP, Single Phase)

Figure 6-3, Electrical System (Model 1000)