



**800-321-3396**

# HOPPERS

Wastequip hoppers were previously sold under the Galbreath brand, and still offer the same quality users have trusted for years.



# SELF-DUMPING HOPPERS



**Wastequip hoppers are great for storing, transporting and dumping scrap and bulk material.** Self-dumping hoppers are designed for industrial, commercial and institutional applications and are particularly useful for in-plant housekeeping, in-process material handling, sorting and storing, scrap collection, materials recycling and other rugged applications. Self-dumping hoppers allow for safe and easy loading, transporting and dumping of material. Wastequip hoppers are available in a variety of configurations to fit your application. Hoppers have standard red oxide primer finish or can be painted in a variety of colors.

## FEATURES

- Standard red oxide primer finish
- Unique tapered press-fitted rocker pin that self-centers front and back and side to side when “rocked in”
- Standard hopper lock **1**
- Press-fitted locker pin **2**
- Spring-loaded latch with reinforced latch pin



## THE WASTEQUIP HOPPER PRODUCT OFFERING INCLUDES:



**HEAVY-DUTY SELF-DUMPING HOPPERS**  
1/8 to 1- 1/2 cubic yard hoppers



**HEAVY-DUTY SELF-DUMPING HOPPERS  
(Large Capacity)**  
1- 1/2 to 5 cubic yard hoppers



**HEAVY-DUTY SELF-DUMPING HOPPERS  
(Low Profile)**  
2- 1/2 to 3-1/2 cubic yard hoppers



**LIGHT-DUTY SELF-DUMPING HOPPERS**  
1/2 to 2-1/2 cubic yard hoppers



**OPEN-END SELF-DUMPING HOPPERS**



**DOCK CARTS**



# LIGHT-DUTY SELF-DUMPING HOPPERS

## 1/2 TO 2-1/2 CUBIC YARD HOPPERS

Wastequip light-duty self-dumping hoppers are ideal for lightweight materials or bulky materials that take up more space than weight. These hoppers are a great fit for lightweight recycling, plant maintenance, wood scraps of all types (sawdust, pallets, cabinets, paper mills) as well as cardboard, plastic and metal shavings. Hoppers are constructed of 12 gauge steel with fully welded rocker stop supports and formed base.

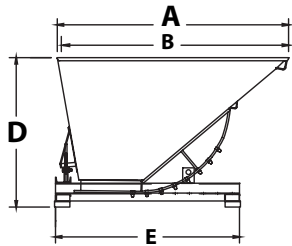

1/2, 1, 1-1/2 cubic yard hoppers

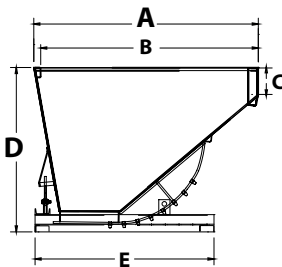

2, 2-1/2 cubic yard hoppers

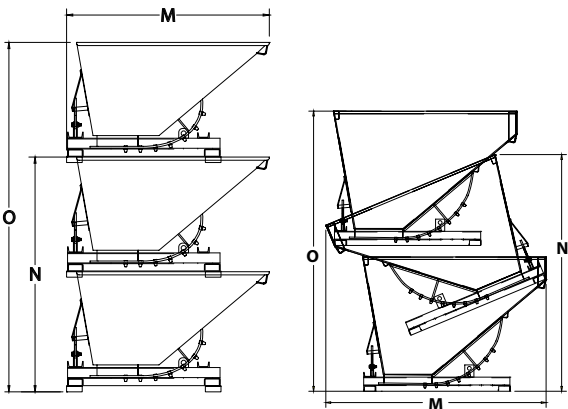
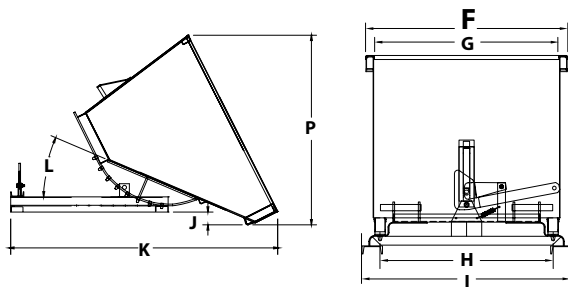

## FEATURES

- 12 gauge steel body
- 1" round rocker stops
- Designed for 1,500 to 2,000 lb. capacities

	LH-50	LH-100	LH-150	LH-200	LH-250
<b>Vol. capacity (cu. yds.)</b>	1/2	1	1-1/2	2	2-1/2
<b>Weight capacity (lbs.)</b>	1,500	1,500	2,000	2,000	2,000
<b>Shipping weight (lbs.)</b>	369	417	472	509	570
<b>A - Outside Dimension</b>	49-1/4"	60-1/2"	60-1/2"	60-1/2"	60-1/2"
<b>B</b>	47-1/2"	58-1/2"	58-1/2"	58-3/8"	58-3/8"
<b>C</b>	n/a	n/a	n/a	7-1/4"	7-1/4"
<b>D - Outside Dimension</b>	30-3/4"	39"	37-1/2"	44"	44"
<b>E</b>	39-1/4"	48"	48"	48"	48"
<b>F - Outside Dimension</b>	39-3/4"	39-3/4"	58-1/4"	58-1/4"	72-1/2"
<b>G</b>	36-1/2"	36-1/2"	54-3/4"	54-3/4"	54-3/4"
<b>H</b>	36-1/2"	38"	38"	38"	38"
<b>I</b>	40-1/2"	40-1/2"	38-5/8"	38-5/8"	38-5/8"
<b>J</b>	8-3/8"	3-1/2"	3-1/2"	3-7/8"	3-7/8"
<b>K</b>	59"	76"	76"	81-1/2"	81-1/2"
<b>L</b>	29°	21.5°	21.5°	25°	25°
<b>M</b>	55"	66"	67"	75"	75"
<b>N</b>	59-1/2"	77"	70"	78"	78"
<b>O</b>	89"	114"	77-1/2"	93-1/2"	93-1/2"
<b>P</b>	47"	54"	57"	58"	58"

NOTE: The LH-50 and LH-100 stack. The LH-150, LH-200 and LH-250 nest.



# HEAVY-DUTY SELF-DUMPING HOPPERS

## 1/8 TO 1- 1/2 CUBIC YARD HOPPERS

Wastequip heavy-duty self-dumping hoppers are designed for forklift handling of materials, particularly for demanding applications such as commercial construction, machine shops, fabrication, in-process material handling, sorting and storing operations, materials recycling and scrap collection for metal, glass, stone and more. The 7 gauge steel body features a channel for additional support on the hopper body and an angle-reinforced formed steel base with 1" plate rocker stops. Rocker allows hopper to roll forward and backward for easier dumping with the pull of a handle. Rocker stops lock the hopper in place for safety.

### FEATURES

- Heavy-duty 7 gauge steel body
- 1" round rocker stops
- Designed for 1,500 to 6,000 lb. capacities

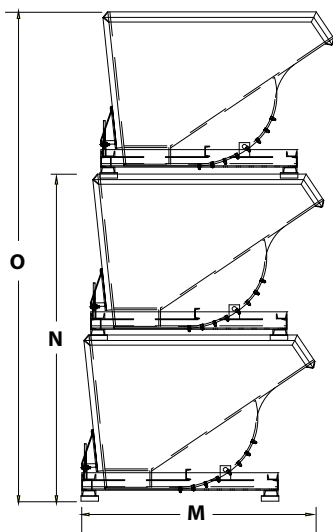
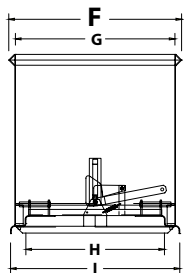
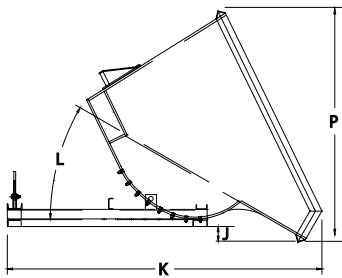
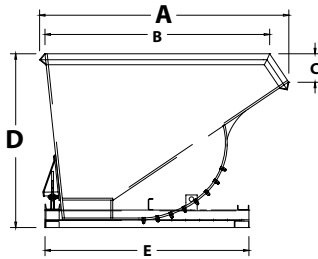

	H-125	H-25	H-375	H-50N	H-50	H-75	H-100	H-150
<b>Vol. capacity (cu. yds.)</b>	1/8	1/4	3/8	1/2	1/2	3/4	1	1-1/2
<b>Weight capacity (lbs.)</b>	1500	3,000	3,000	4,000	4,000	5,000	6,000	6,000
<b>Shipping weight (lbs.)</b>	254	400	420	420	460	580	600	750
<b>A - Outside Dimension</b>	31"	46-3/8"	47"	49-1/4"	47-3/16"	59"	62-1/8"	66"
<b>B</b>	30-1/2"	45-3/4"	44"	46-1/4"	44"	55-1/2"	58"	59-3/4"
<b>C</b>	0	0	2-1/2"	5-1/4"	2-1/2"	3"	4"	8"
<b>D - Outside Dimension</b>	17-1/2"	26-1/2"	31"	35-1/2"	31"	36"	38"	46"
<b>E</b>	29"	42-1/2"	42-1/2"	42-1/2"	42-1/2"	48"	48"	54-1/2"
<b>F - Outside Dimension</b>	31"	30-1/8"	32-1/4"	32-1/4"	39"	39"	39-1/2"	44-1/2"
<b>G</b>	30"	29"	29"	29"	36"	36"	36"	41"
<b>H</b>	25"	23-1/2"	23-1/2"	23-1/2"	30-1/4"	30-1/4"	30-1/4"	35-1/2"
<b>I</b>	31"	31-3/4"	31-1/2"	31-1/2"	39"	39"	39"	43-1/2"
<b>J</b>	4-1/2"	7"	6"	8"	7"	11"	9"	6"
<b>K</b>	39"	56-1/2"	60"	65"	60"	71"	75"	85"
<b>L</b>	45°	45°	42°	42°	42°	41°	35°	35°
<b>M</b>	n/a	52"	54"	61"	58"	65"	68"	73"
<b>N</b>	n/a	51-1/2"	60-3/4"	69-1/2"	61-1/2"	72-3/4"	75-1/4"	91-1/2"
<b>O</b>	n/a	76-1/2"	90-1/2"	103-1/2"	91-1/2"	108-1/2"	112-1/4"	136-1/2"
<b>P</b>	29-1/2"	45"	46"	49"	46"	57"	58"	63"



# HEAVY-DUTY SELF-DUMPING HOPPERS (LARGE CAPACITY)

## 1- 1/2 TO 5 CUBIC YARD HOPPERS

Wastequip heavy-duty self-dumping, large capacity hoppers are designed for “shock” loads or conveyor feed applications for foundries, scrap haulers and similar applications that require a structural base. They feature a 7 gauge steel body with angle reinforcements and structural steel base.

### FEATURES

- Heavy-duty 7 gauge steel body
- 1" round rocker stops on 1-1/2, 2, 2-1/2 yd. models
- 1/4" round rocker stops on 3, 4 and 5 yd. models
- Designed for 4,000 to 6,000 lb. capacities

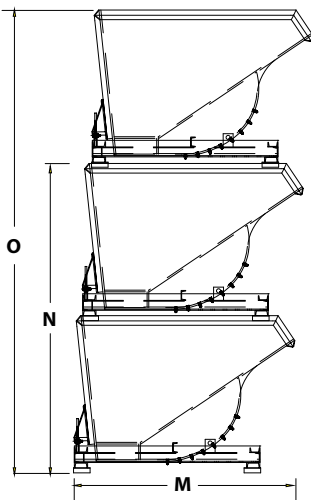
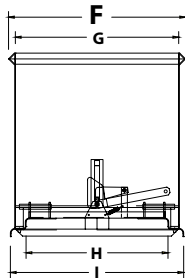
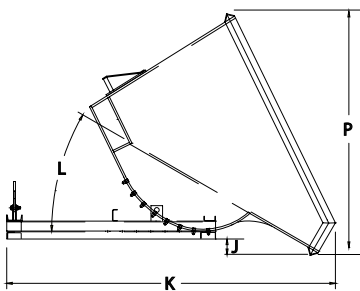
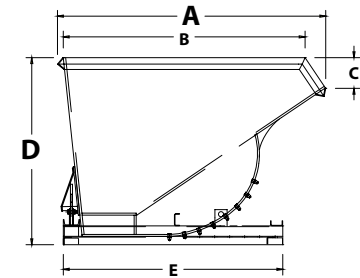

	H-150W	H-200	H-250	H-300	H-400	H-500
<b>Vol. capacity (cu. yds.)</b>	1-1/2	2	2 1/2	3	4	5
<b>Weight capacity (lbs.)</b>	6,000	6,000	6,000	5,000	4,000	4,000
<b>Shipping weight (lbs.)</b>	790	920	950	1,250	1,430	1,570
<b>A - Outside Dimension</b>	62"	66"	67"	73-3/8"	73-3/8"	73-3/8"
<b>B</b>	58"	59-1/2"	56"	63"	63"	63"
<b>C</b>	3-7/8"	8"	15"	11-1/2"	11-1/2"	11-1/2"
<b>D - Outside Dimension</b>	39-3/8"	48"	55"	58-1/2"	58-1/2"	58-1/2"
<b>E</b>	48-1/2"	56-1/2"	56-1/2"	59"	59"	59"
<b>F - Outside Dimension</b>	57-1/2"	57"	57-9/16"	63-7/8"	83-7/8"	103-7/8"
<b>G</b>	54"	54"	54"	60"	80"	100"
<b>H</b>	32"	32"	32"	32"	32"	32"
<b>I</b>	58"	58"	58"	57"	57"	57"
<b>J</b>	8"	5"	4"	1/2"	1/2"	1/2"
<b>K</b>	75"	87"	93"	98"	98"	98"
<b>L</b>	37°	32°	35°	25°	25°	25°
<b>M</b>	74"	78"	79"	n/a	n/a	n/a
<b>N</b>	78-3/4"	94-3/4"	108-3/4"	n/a	n/a	n/a
<b>O</b>	117-1/2"	141-1/2"	162-1/2"	n/a	n/a	n/a
<b>P</b>	59"	65"	68"	60"	60"	60"



# HEAVY-DUTY SELF-DUMPING HOPPERS (LOW PROFILE)

## 2- 1/2 TO 3-1/2 CUBIC YARD HOPPERS

Wastequip heavy-duty self-dumping hoppers with low profile design offer the advantage of increased capacity for equipment that requires a lower height requirement. Units incorporate a new heavy-duty base for forklift handling of materials, in-plant house-keeping, scrap collection and more. These hoppers feature a 7 gauge body with angle reinforcement and 1" round rocker stops.

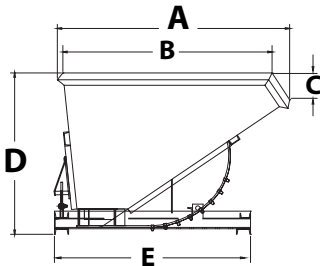

### FEATURES

- Heavy-duty 7 gauge steel body
- 1" round rocker stops
- Designed for 5,000 to 6,000 lb. capacities

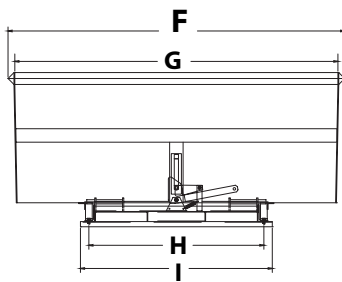
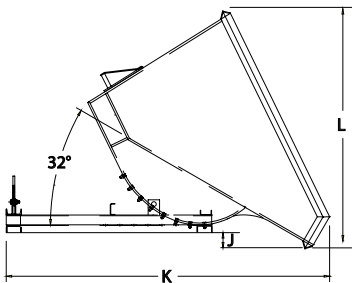

	H-250LP	H-300LP	H-350LP
<b>Vol. capacity (cu. yds.)</b>	2 1/2	3	3-1/2
<b>Weight capacity (lbs.)</b>	6,000	5,000	5,000
<b>Shipping weight (lbs.)</b>	1,151	1,304	1,416
<b>A - Outside Dimension</b>	66-1/2"	66-1/4"	66"
<b>B</b>	59-1/2"	59-1/2"	59-1/2"
<b>C</b>	7-1/2"	7-1/2"	7-1/2"
<b>D - Outside Dimension</b>	46"	46"	46"
<b>E</b>	56-1/2"	56-1/2"	56-1/2"
<b>F - Outside Dimension</b>	66"	85-1/2"	99-1/2"
<b>G</b>	62"	82"	96"
<b>H</b>	47-3/4"	47-3/4"	47-3/4"
<b>I</b>	57"	57"	57"
<b>J</b>	5"	5"	5"
<b>K</b>	87"	87"	87"
<b>L</b>	65"	65"	65"



# OPEN-END SELF-DUMPING HOPPERS

Wastequip open-end self-dumping hoppers are constructed from heavy gauge steel and designed for forklift handling of long materials. This hopper is ideal for lumber, plastic/metal pipe or re-bar, large sheet material, construction material or fencing scraps. It is designed to handle a variety of debris varying in length and thickness. These hoppers are constructed of 7 gauge formed channel frame and formed steel base equipped with 1" round rocker stops.

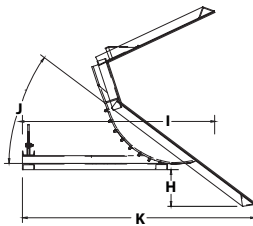
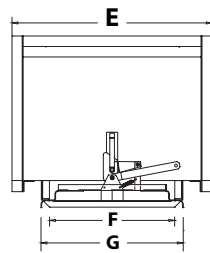
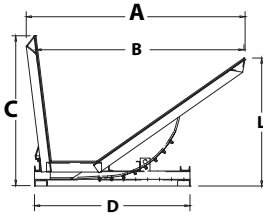

	HOE-1	HOE-2
<b>Shipping weight (lbs.)</b>	360	690
<b>A - Outside Dimension</b>	47-1/2"	67-1/2"
<b>B</b>	45"	64-1/2"
<b>C - Outside Dimension</b>	30"	46-3/4"
<b>D</b>	42-1/2"	48-1/8"
<b>E - Outside Dimension</b>	42" (min.)	54" (min.)
<b>F</b>	30-1/2"	30-1/2"
<b>G</b>	38"	38-1/2"
<b>H</b>	6-5/8"	12-1/2"
<b>I</b>	49"	63-1/4"
<b>J</b>	42°	37°
<b>K</b>	57"	77"
<b>L</b>	28"	39-1/4"

## FEATURES

- Heavy-duty 7 gauge formed channel frame and formed steel base
- 1" round rocker stops
- Designed for 360 to 690 lb. capacities

# DOCK CARTS

Wastequip dock carts are designed for manual handling of paper, wood and other lightweight, in-plant materials. The carts feature a 14 gauge steel body. Casters include two rigid and two swivel casters along with 6" x 2" rubber mold-on casters.

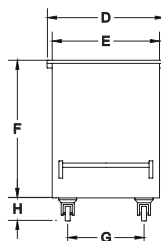
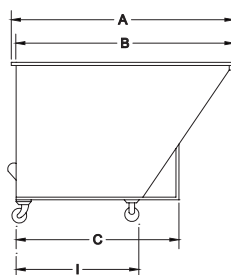

	DC-100	DC-150	DC-200
<b>Vol. capacity (cu. yds.)</b>	1	1-1/2	2
<b>Weight capacity (lbs.)</b>	1,600	1,600	1,600
<b>Shipping weight (lbs.)</b>	215	253	287
<b>A</b>	59"	59"	59"
<b>B</b>	57"	57"	57"
<b>C</b>	41"	41"	41"
<b>D</b>	30-1/2"	44-5/8"	57-5/8"
<b>E</b>	27"	41"	54"
<b>F</b>	35-1/2"	35-1/2"	35-1/2"
<b>G</b>	21"	35"	48"
<b>H</b>	7-1/2"	7-1/2"	7-1/2"
<b>I</b>	33"	33"	33"

## FEATURES

- 14 gauge steel body
- Designed for 1,600 lb. capacities

# HOPPER OPTIONS

## CASTERS

Semi-steel, phenolic, rubber mold-on or polyurethane (two swivel and two rigid) casters available.



Semi-steel



Phenolic



Rubber Mold-on



Polyurethane

OPTION	TYPE	CAPACITY	WHEEL	BEARING	HEIGHT	WEIGHT
<b>NO. 1</b>	4" Semi-Steel	3200 lbs.	4" x 1-1/2"	Roller	5-3/4"	28 lbs.
<b>NO. 2</b>	6" Semi-Steel	3400 lbs.	6" x 2"	Roller	7-1/2"	46 lbs.
<b>NO. 3</b>	8" Semi-Steel	4200 lbs.	8" x 2"	Roller	10"	64 lbs.
<b>NO. 4</b>	6" Phenolic	3600 lbs.	6" x 2"	Self Lubricating	7-1/2"	44 lbs.
<b>NO. 5</b>	6" Rubber - Mold-On	1640 lbs.	6" x 2"	Roller	7-1/2"	42 lbs.
<b>NO. 6</b>	8" Rubber - Mold-On	2000 lbs.	8" x 2"	Roller	10"	60 lbs.
<b>NO. 7A</b>	6" Polyurethane	3600 lbs.	6" x 2"	Roller	7-1/4"	36 lbs.
<b>NO. 7B</b>	8" Polyurethane	3600 lbs.	8" x 2"	Roller	9-1/2"	38 lbs.

Castors not available for models H-300, H-300LP, H350LP, H400 or H500.

## HOPPER COVERS

Hopper covers offer debris containment and security. Constructed of carbon steel, these covers feature an X-cripp design for water drainage.

OPTION	HOPPER SIZE	TYPE A	TYPE B	TYPE C
<b>NO. 16</b>	1/2 yd.	50 lbs.	56 lbs.	54 lbs.
<b>NO. 17</b>	3/4 and 1 yd.	59 lbs.	64 lbs.	62 lbs.
<b>NO. 18</b>	1-1/2 yd.	80 lbs.	86 lbs.	85 lbs.
<b>NO. 19</b>	2 yd.	102 lbs.	110 lbs.	108 lbs.
<b>NO. 20</b>	2-1/2 yd.	109 lbs.	117 lbs.	114 lbs.

Covers are a non-inventory item. Please allow additional manufacturing time.

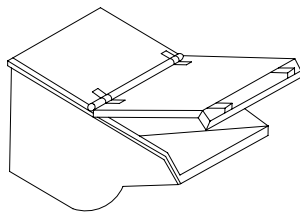

TYPE A

Weld on back with single center hinge

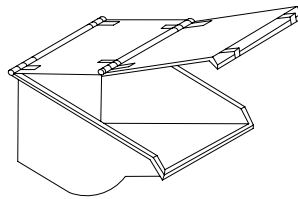

TYPE B

Double hinged - Back and center

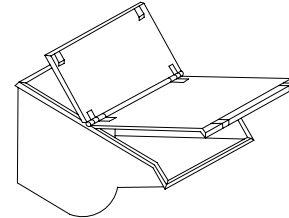

TYPE C

Single hinged center

## OPTIONS

- Hopper retaining chain and bracket **1**
- Hopper floor lock **2**
- Three-way entry (1/4 to 3 cubic yard sizes only) **3**
- Platform legs **4**
- Pull bracket with 10' nylon rope **5**
- Drain plug
- Drain sump
- Crane pick-up eyes
- Available in multiple paint options



**NASCO-OP™**  
Power of Numbers  
800-321-3396

### Standard Color Choices\*



Colors shown are as accurate as printing allows. The actual color is subject to variation from the printed color sample. Color choices vary by plant location. Please contact your local sales representative for available colors. Custom colors are available upon request and are subject to an additional charge.



Wastequip is the leading North American manufacturer of waste and recycling equipment for collecting, processing and transporting recyclables and solid or liquid waste. © Wastequip, August 2015. All rights reserved. Specifications subject to improvement without notice. Equipment displayed should be operated by properly trained personnel. Operators should become familiar with OSHA, ANSI and any other applicable standards or laws for using this equipment. Improper use, misuse, or lack of maintenance could cause injury to people and/or property. Photos used in the literature are illustrative only. We assume no liability or responsibility for proper training/operation of equipment not manufactured by Wastequip. We reserve the right to make changes at any time without notice. Information contained within this literature is intended to be the most accurate available at time of printing.